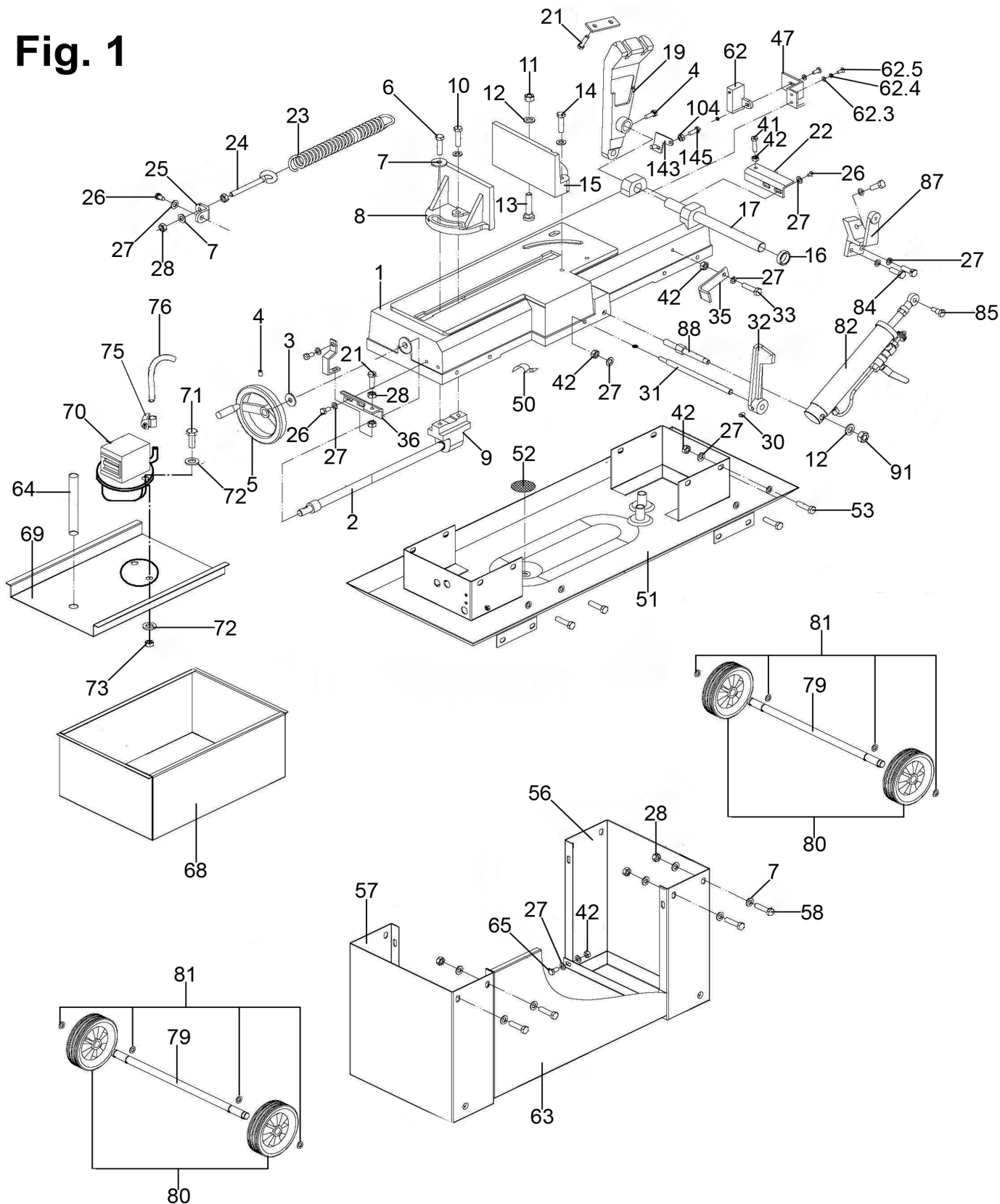

Fig. 1



NOTE: It is our policy to continually improve products and as such we reserve the right to alter data, specifications and component parts without prior notice. There may be alternative versions of this product, please contact us should you require this information.

IMPORTANT: No liability is accepted for incorrect use of product. Spare parts must be fitted by a competent person

WARRANTY: Guarantee is 12 months from purchase date, proof of which will be required for any claim.



Parts Information:
**Bandsaw 300mm Horizontal Hydraulic
 Arm**
Model No: SM35CE.V4

Item	Part No.	Description
1	SM35CE.V4-001	Table
2	SM35CE.V4-002	Screw
3	FWM16.S	Flat Washer M16
4	GSM812.S	Grub Screw M8 x 12mm
5	SM35CE.V4-005	Hand Wheel
6	SM35CE.V4-006	Hex Screw 3/8" x 1-1/4"
7	FWM10.S	Flat Washer M10
8	SM35CE.V4-008	Front Bracket, Vice Jaw
9	SM35CE.V4-009	Bracket
10	SS1040.S	Hex Head Set Screw M10 x 40mm
11	SM35CE.V4-011	Hex Nut 1/2"
12	FWM12.S	Flat Washer M12
13	SM35CE.V4-013	Carriage Roll
14	SS1050.S	Hex Head Set Screw M10 x 50mm
15	SM35CE.V4-015	Rear Bracket, Vice Jaw
16	SM35CE.V4-016	Bushing
17	SM35CE.V4-017	Support Rod
19	SM35CE.V4-019	Pivot Bracket
21	SS1030.S	Hex Head Set Screw M10 x 30mm
22	SM35CE.V4-022	Support Plate
23	SM35CE.V4-023	Spring
24	SM35CE.V4-024	Rod, Spring Adjust
25	SM35CE.V4-025	Spring, Handle Bracket
26	SS816.S	Hex Head Set Screw M8 x 16mm
27	FWM8.S	Flat Washer M8
28	SN10.S	Steel Nut M10
30	SS830.S	Hex Head Set Screw M8 x 30mm
31	SM35CE.V4-031	Rod, Stock Stop
32	SM35CE.V4-032	Stop Block
33	SM35CE.V4-033	Hex Screw 5/16" x 5/8"
35	SM35CE.V4-035	Support Plate A
36	SM35CE.V4-036	Support Plate B
41	SS835.S	Hex Head Set Screw M8 x 35mm
42	SN8.S	Steel Nut M8
50	SM35CE.V4-050	Wire Retainer
51	SM35CE.V4-051	Coolant Pan
52	SM35CE.V4-052	Filter

Item	Part No.	Description
53	SM35CE.V4-053	Hex Screw 5/16" x 1-1/4"
56	SM35CE.V4-056	Leg, Right
57	SM35CE.V4-057	Leg, Left
58	SS1020.S	Hex Head Set Screw M10 x 20mm
62	SM35CE.V4-062	limit Switch Assembly
62.3	SM35CEV4062-3	Spring Washer
62.4	SM35CEV4062-4	Washer
62.5	SM35CEV4062-5	Round Hd Screw
63	SM35CE.V4-063	Panel
64	SM35CE.V4-064	Hose
65	SM35CE.V4-065	Hex Screw 5/16" x 5/8"
68	SM35CE.V4-068	Coolant Tank
69	SM35CE.V4-069	Pump Support
70	SM35CEV4.070N	Cooling Pump
71	MSP525.S	Machine Screw Pan Head Phillips M5 x 25mm
72	FWM5.S	Flat Washer M5
73	SN5.S	Steel Nut M5
75	SM35CE.V4-075	Hose Clamp
76	SM35CE.V4-076	Hose
79	SM35CE.V4-079	Wheel Rod
80	SM35CE.V4-080	Wheel
81	SM900/M41	Circlip
82	SM35CE.V4-082	Cylinder
84	SS825.S	Hex Head Set Screw M8 x 25mm
85	SM35CE.V4-085	Hex Screw 3/8" x 1-1/4"
87	SM35CE.V4-087	Cylinder Bracket
88	SM35CE.V4-088	Support Body
91	SN12.S	Steel Nut M12
104	FWM6.S	Flat Washer M6
143	SM35CE.V4-143	Switch Hip
145	SS625.S	Hex Head Set Screw M6 x 25mm
--	MSP615.S	Machine Screw Pan Head Phillips M6 x 15mm (Not Shown)
--	SM35CE.V4-061	Safety Switch Assembly (Not Shown)
--	SM35CEV4062-6	Hex Nut (Not Shown)
--	SM35CE.V4-074	Hose Fitting (Not Shown)
--	SWM12.S	Spring Washer M12 (Not Shown)

NOTE: It is our policy to continually improve products and as such we reserve the right to alter data, specifications and component parts without prior notice. There may be alternative versions of this product, please contact us should you require this information.

IMPORTANT: No liability is accepted for incorrect use of product. Spare parts must be fitted by a competent person

WARRANTY: Guarantee is 12 months from purchase date, proof of which will be required for any claim.

Sealey Group, Kempson Way, Suffolk Business Park, Bury St Edmunds, Suffolk. IP32 7AR



01284 757500



01284 703534



sales@sealey.co.uk



www.sealey.co.uk

Fig. 2

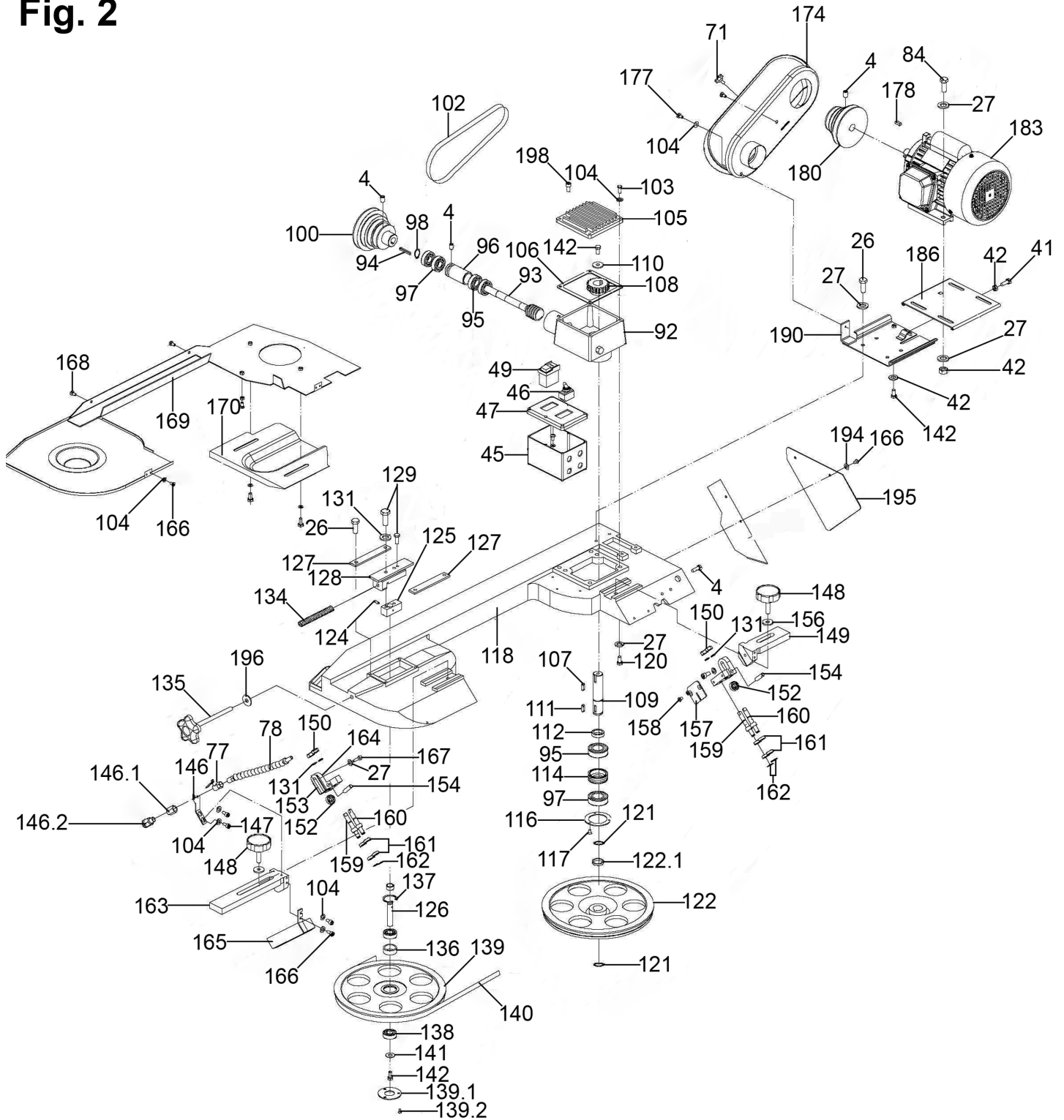

NOTE: It is our policy to continually improve products and as such we reserve the right to alter data, specifications and component parts without prior notice. There may be alternative versions of this product, please contact us should you require this information.

IMPORTANT: No liability is accepted for incorrect use of product. Spare parts must be fitted by a competent person

WARRANTY: Guarantee is 12 months from purchase date, proof of which will be required for any claim.



Parts Information:
**Bandsaw 300mm Horizontal Hydraulic
 Arm**
Model No: SM35CE.V4

Item	Part No.	Description
4	GSM812.S	Grub Screw M8 x 12mm
26	SS816.S	Hex Head Set Screw M8 x 16mm
27	FWM8.S	Flat Washer M8
41	SS835.S	Hex Head Set Screw M8 x 35mm
42	SN8.S	Steel Nut M8
45	SM35CE.V4-045	Electrical Box
46	SM35CE.V4-046	Coolant Switch
47	SM35CE.V4-047	Cover
49	SM35CE.V4-049	Power Switch
71	MSP525.S	Machine Screw Pan Head Phillips M5 x 25mm
84	SS825.S	Hex Head Set Screw M8 x 25mm
92	SM35CE.V4-092	Gear Box
93	SM35CE.V4-093	Worm Shaft
94	SM35CE.V4-094	Woodruff Key
95	B/6003ZZ	Bearing
96	SM35CE.V4-096	Bearing Bushing
97	B/6003Z	Bearing
98	SM35CE.V4-098	External Circlip
100	SM35CE.V4-100	Worm Pulley
102	V/A24.5	V-Belt
103	SM35CE.V4-103	Hex Screw 1/4" x 5/8"
104	FWM6.S	Flat Washer M6
105	SM35CE.V4-105	Cover, Gear Box (Small)
106	SM35CE.V4-106	Gasket, Gear Box (Small)
107	SM35CE.V4-107	Woodruff Key
108	SM35CE.V4-108	Worm Gear
109	SM35CE.V4-109	Transmission Shaft
110	MC4500.P5	Circlip
111	SM35CE.V4-111	Woodruff Key
112	SM35CE.V4-112	Bushing
114	SM35CE.V4-114	Bearing Bushing
116	SM35CE.V4-116	Bearing Cover
117	MSP48.S	Machine Screw Pan Head Phillips M4 x 8mm
118	SM35CE.V4-118	Body Frame
120	SS840.S	Hex Head Set Screw M8 x 40mm
121	SM35CE.V4-121	Circlip
122	SM35CE.V4-122	Blade Wheel, Rear
122.1	SM35CEV4122-1	Saw Wheel, Active

Item	Part No.	Description
124	500ETJV2-11	Spring Pin
125	SM35CE.V4-125	Sliding Draw Block
126	SM35CE.V4-126	Blade Wheel Shaft, Front
127	SM35CE.V4-127	Sliding Guide Plate
128	SM35CE.V4-128	Blade Tension Sliding Block
129	SS840.S	Hex Head Set Screw M8 x 40mm
131	SWM8.S	Spring Washer M8
134	SM35CE.V4-134	Spring
135	SM35CE.V4-135	Knob, Blade Adjust
136	SM35CE.V4-136	Bearing Bushing
137	SM35CE.V4-137	Circlip
138	B/620ZZ	Bearing
139	SM35CE.V4-139	Blade Wheel, Front
139.1	SM35CEV4139-1	Bearing Cap
139.2	SM35CEV4139-2	Hd Screw
140	SM35/B08	Bandsaw Blade 8TPI
141	SM35CE.V4-141	Washer
142	SS815.S	Hex Head Set Screw M8 x 15mm
146	SM35CE.V4-146	Support, Nozzle
146.1	SM35CEV4146-1	Joint
146.2	SM35CEV4146-2	Water Pipe Head
147	MSP66.S	Machine Screw Pan Head Phillips M6 x 6mm
148	SM35CE.V4-148	Knob
149	SM35CE.V4-149	Adjustable Bracket, Rear
150	SM35CE.V4-150	Hex Nut 3/8"
152	B/629ZZ	Bearing
153	SM35CE.V4-153	Blade Adjust, Rear
154	SM35CE.V4-154	Bearing Pin
156	SCB830.S	Socket Cap Bolt M8 x 30mm
157	SM35CE.V4-157	Deflector Plate
158	MSC614.S	Csk Phillips Machine Screw M6 x 14mm
159	SM35CE.V4-159	Bearing Shaft
160	SM35CE.V4-160	Eccentric Shaft
161	B/629ZZ	Bearing
162	SM35CE.V4-162	Circlip
163	SM35CE.V4-163	Adjustable Bracket, Front
164	SM35CE.V4-164	Blade Adjust, Front

NOTE: It is our policy to continually improve products and as such we reserve the right to alter data, specifications and component parts without prior notice. There may be alternative versions of this product, please contact us should you require this information.

IMPORTANT: No liability is accepted for incorrect use of product. Spare parts must be fitted by a competent person

WARRANTY: Guarantee is 12 months from purchase date, proof of which will be required for any claim.

Sealey Group, Kempson Way, Suffolk Business Park, Bury St Edmunds, Suffolk. IP32 7AR



01284 757500



01284 703534



sales@sealey.co.uk



www.sealey.co.uk



Parts Information:
**Bandsaw 300mm Horizontal Hydraulic
Arm**
Model No: SM35CE.V4

Item	Part No.	Description
165	SM35CE.V4-165	Blade Cover, Front
166	MSP612.S	Machine Screw Pan Head Phillips M6 x 12mm
167	SCB830.SB	Socket Cap Bolt M8 x 30mm Black
168	MSP510.S	Machine Screw Pan Head Phillips M5 x 10mm
169	SM35CE.V4-169	Blade Cover, Rear
170	SM35CE.V4-170	Wheel Cover
174	SM35CE.V4-174	Motor Pulley Cover Assembly
177	MSP616.S	Machine Screw Pan Head Phillips M6 x 16mm
178	SM35CE.V4-178	Key
180	SM35CE.V4-180	Motor Pulley
183	SM35CE.V5-183	Motor
186	SM35CE.V4-186	Mount Plate, Motor
190	SM35CE.V4-190	Bracket, Motor Mount
194	RW619.S	Repair Washer M6 x 19mm
195	SM35CE.V4-195	Support Plate
196	SM35CE.V4-196	Washer 3/8"
198	SCB810.SB	Socket Cap Bolt M8 x 10mm Black
--	SM35CEV4-105L	Cover, Gear Box (Large)(Not Shown)
--	SM35CEV4-106L	Gasket, Gear Box (Large)(Not Shown)

Item	Part No.	Description
--	SS625.S	Hex Head Set Screw M6 x 25mm (Not Shown)
--	SM35CE.V4-197	Nut (Not Shown)
--	SM35CE.V4-199	Nut (Not Shown)
--	SM35CE.V4-200	Button (Not Shown)
--	SM35CE.V4-201	Retainer (Not Shown)
--	SWM5.S	Spring Washer M5 (Not Shown)
--	MSP56.S	Machine Screw Pan Head Phillips M5 x 6mm (Not Shown)
--	SM35CE.V4-204	Hose R-Ring (Not Shown)
--	SM35/B14	Bandsaw Blade 14TPI (Not Shown)
--	SM35/B14-BIM	Bandsaw Blade 14TPI (Not Shown)
--	SM35/B18	Bandsaw Blade 18TPI (Not Shown)
--	SM35/B24	Bandsaw Blade 24TPI (Not Shown)
--	SM35/B04	Bandsaw Blade 4TPI (Not Shown)
--	SM35CE.V4-B	Bracket, Brush (Not Shown)
--	SM35CE.V4-SB	Small Brush (c/w Screw)(Not Shown)
--	SM35CE.V4-76A	Hose Clip (Not Shown)
--	SM35CE.V4-BB	Bracket + Brush Assembly (Not Shown)
--	SM35CE.V4-H	Handle (Not Shown)
--	SM35CE.V4-CC	Capacitor Cover (Not Shown)

NOTE: It is our policy to continually improve products and as such we reserve the right to alter data, specifications and component parts without prior notice. There may be alternative versions of this product, please contact us should you require this information.

IMPORTANT: No liability is accepted for incorrect use of product. Spare parts must be fitted by a competent person

WARRANTY: Guarantee is 12 months from purchase date, proof of which will be required for any claim.

Sealey Group, Kempson Way, Suffolk Business Park, Bury St Edmunds, Suffolk. IP32 7AR



01284 757500



01284 703534



sales@sealey.co.uk



www.sealey.co.uk