

SEALEY

GENERATOR 2200W 230V 6.5HP

MODEL NO: **G2201.V2**

Thank you for purchasing a Sealey product. Manufactured to a high standard, this product will, if used according to these instructions, and properly maintained, give you years of trouble free performance.

IMPORTANT: PLEASE READ THESE INSTRUCTIONS CAREFULLY. NOTE THE SAFE OPERATIONAL REQUIREMENTS, WARNINGS & CAUTIONS. USE THE PRODUCT CORRECTLY AND WITH CARE FOR THE PURPOSE FOR WHICH IT IS INTENDED. FAILURE TO DO SO MAY CAUSE DAMAGE AND/OR PERSONAL INJURY AND WILL INVALIDATE THE WARRANTY. KEEP THESE INSTRUCTIONS SAFE FOR FUTURE USE.



- 1 Refer to instruction manual



- 2 Hot parts.
Keep your distance



- 3 Switch off the engine
Before refuelling



- 4 Never operate in
Non-ventilated rooms

1. SAFETY

- WARNING! Ensure any Health & Safety, Government, or local authority regulations are adhered to when using this equipment.**
- Familiarise yourself with the application and limitations, as well as the potential hazards, of the generator.
- Maintain the generator in good condition (use an authorised service agent). Replace or repair damaged parts. Use genuine parts only. Unauthorised parts may be dangerous and will invalidate the warranty.
- This generator is designed and manufactured for specific applications. **DO NOT** attempt to modify the unit or use it for any application for which it is not designed. If you have any questions regarding the application of the unit please contact your local Sealey stockist.
- WARNING! DO NOT** exceed the Wattage/Amperage capacity of the generator. Add rated wattage of all devices intended for connection at any one time, the total must not exceed rated wattage of generator (see specifications).
- WARNING!** Generator exhaust gases contain deadly carbon monoxide which must not be inhaled. Always allow sufficient ventilation.
- WARNING!** If you decide to use an Earth Leakage Circuit Breaker (also referred to as an RCD or Ground Fault Circuit Interrupter), it is imperative that the neutral end of the power winding is connected to the frame of the generator set and that the earth lug on the frame is connected with a low impedance connector to the local earth via an earth spike or local protective earth conductor. This connection should only be attempted by a qualified electrician, after first having consulted your local stockist.
- DANGER!** This generator is designed for outdoor use only. To use the generator inside any building or enclosure, including the generator compartment of a caravan, may result in fire or an explosion. No user performed modifications, including venting of the exhaust and/or cooling ventilation, will eliminate the danger.
- DANGER!** If this unit is used for back-up power in the event of a commercial power failure, the following steps must be taken. Before connecting the generator to the electrical system, open the main circuit breaker to isolate the generator and system from the commercial electric supply. Failure to do this may result in damage to the generator and may result in serious injury or fatality, due to a back-feed of electrical energy.
- DANGER!** The generator produces a very powerful voltage that can cause a severe electrical shock. Avoid contact with bare wires, terminals etc. Never allow any unqualified person to operate or service the generator.
- WARNING!** Petrol is highly flammable and petrol vapour is explosive. Do not permit smoking, naked flames, sparks or heat in the vicinity while handling petrol. Avoid spilling petrol onto a hot engine. Comply with all laws regulating storage and handling of fuels.
- WARNING!** Risk of burns. **DO NOT** touch the exhaust system or the drive unit.
- WARNING!** NEVER refuel when the engine is running or when the engine is hot. Allow cool down time.
- Operate the generator only on level surfaces (maximum allowable tilt is 10°) and where it will not be exposed to excessive moisture, dirt or corrosive vapours or be in the proximity of combustible material (flammable liquids, solids or gases).
- DO NOT** tip or change the generator's position whilst it is operating.
- Remove ill fitting clothing, ties, watches, rings and other loose jewellery and contain long hair. Wear appropriate protective clothing.
- Keep non-essential persons and children away from the working area.
- WARNING!** Never start or stop the generator while electrical loads are connected. Start the engine, let it stabilise, then connect the electrical load. To stop engine, disconnect the electrical load and let engine stabilise before switching off.
- WARNING! DO NOT** use worn, bare, frayed or otherwise damaged electrical cables with the generator. To do so may result in electric shock.
- DO NOT** use the generator for any purpose other than that for which it is designed.
- DO NOT** operate the generator if any parts are missing or damaged, as this may cause failure and/or personal injury.

- × **DO NOT** over-fill fuel tank. Always leave room for fuel to expand.
- × **DO NOT** operate in the rain.
- ▲ **DANGER! DO NOT** tamper with the engine governed speed setting. Higher operating speeds are dangerous and increase the risk of personal injury and/or equipment damage. The generator supplies the correct rated frequencies and voltage only when running at the correct governed speed. Incorrect frequency and/or voltage can damage some connected electrical loads. Operating at excessively low speeds may result in shortened engine life. Over-speeding will invalidate the warranty.
- × **DO NOT** operate the generator when you are tired, or under the influence of alcohol, drugs or intoxicating medication.
- × **DO NOT** store generator with fuel in tank where petrol vapours might reach an open flame or spark.

2. INTRODUCTION

Heavy-duty frame design provides full protection and portability. Suitable for running power tools and lighting units. Long running with up to 13 hours on a full tank. Fitted with two 230V 13A sockets. Powerful and reliable generator. Smooth running unit fitted with anti-vibration engine mounts. Features low oil warning light, overload protection and fuel gauge.

3. SPECIFICATION

Model no: G2201.V2
 Continuous Power Rating:.....2000W
 Current Rating:.....8.7A
 Dimensions (W x D x H):.....595 x 435 x 435mm
 Fuel Tank: 15L
 Maximum Power Rating:2200W
 Maximum Running Time:..... 13hr
 Motor Power:.....4.9kW/6.5hp
 Motor Type:4-Stroke Petrol
 Noise Rating:94dB(A)
 Output: 230V~50Hz

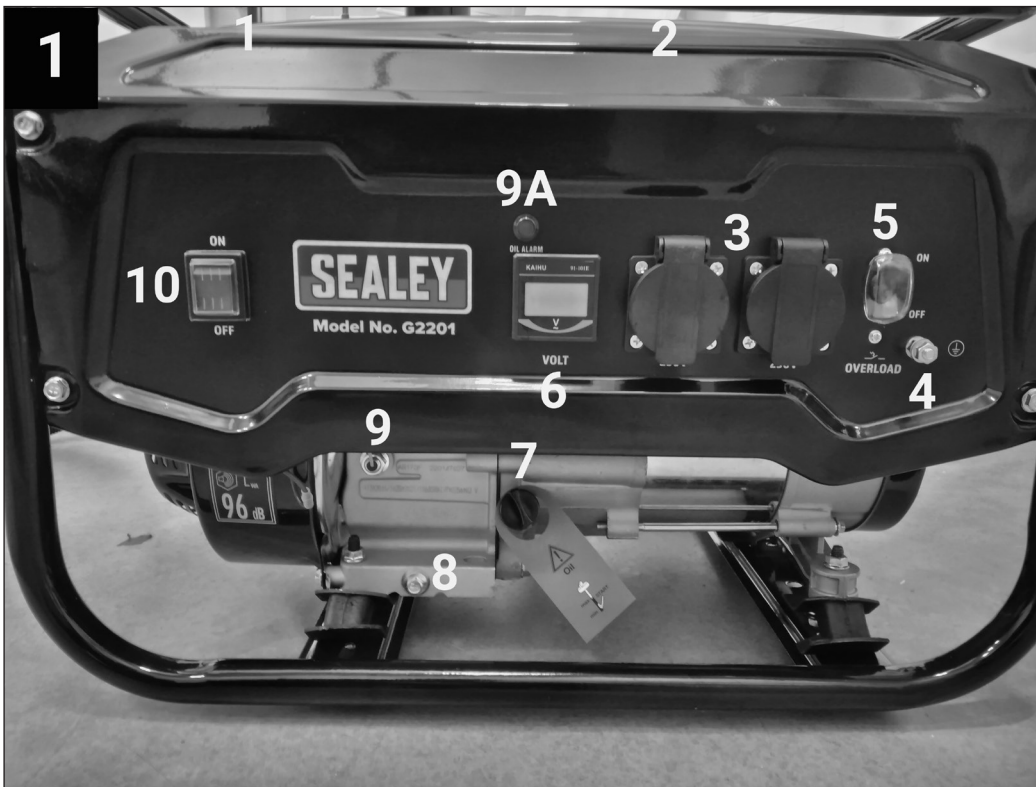

- 1 Tank indicator
- 2 Tank cover
- 3 2 x 230 V~ socket-outlets
- 4 Earth connection
- 5 Safety tripping element
- 6 Voltmeter
- 7 Oil filler plug
- 8 Oil drain plug
- 9 Oil shortage cut-out switch
- 9A Oil shortage alarm light
- 10 On/Off switch
- 11 Choke lever (diagram 2)
- 12 Recoil starter (diagram 2)
- 13 Petrol tap (diagram 2)

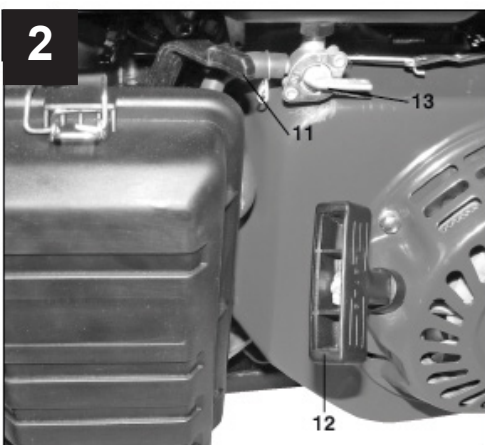

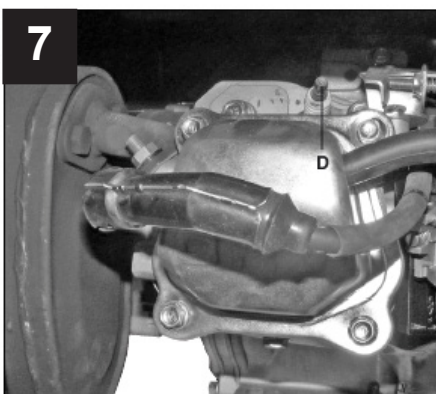
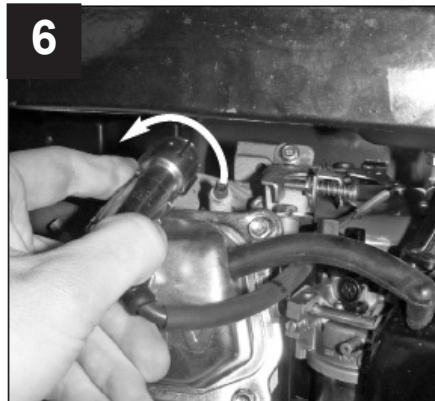
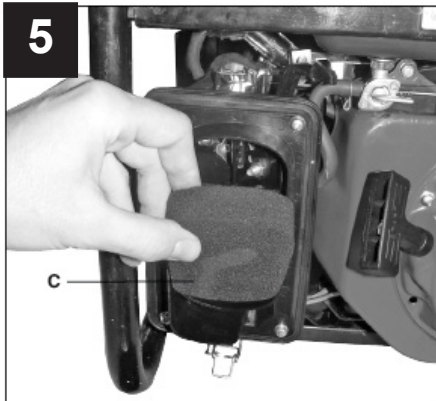
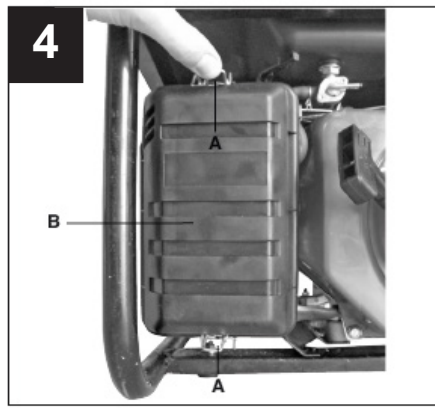
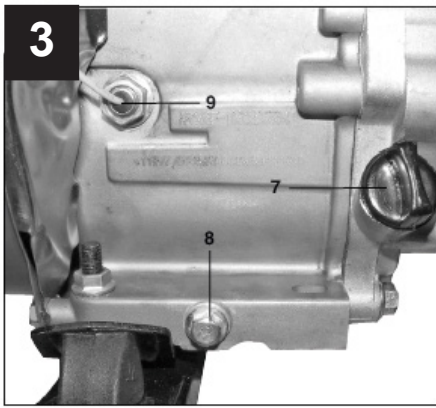

4. SET UP

4.1. ELECTRICAL SAFETY

- 4.1.1. Electric supply cables and connected equipment must be in perfect condition.
- 4.1.2. The generator is to be operated only with equipment whose voltage specifications conform with the generator's output voltage.
- 4.1.3. Never connect the generator to mains power supply.
- 4.1.4. Keep the cable length to the connected equipment as short as possible.

4.2. EARTH CONNECTION

- 4.2.1. The housing is required to be connected to earth in order to discharge static electricity. To do this, connect one end of a cable to the earth connection on the generator, see fig.1.4 and the other end to an external earth (for example an earthing rod).

5. OPERATION

- ▲ **Important: You must fill up with engine oil (approx.0.6L) and fuel before you can start the engine. See fig.3. Oil shortage light will illuminate if engine oil is low, see fig.1.9A.**

- ▲ Check the fuel level and top it up if necessary.

- 5.1. Make sure that the generator has sufficient ventilation.
- 5.2. Make sure that the ignition cable is secured to the spark plug.
- 5.3. Inspect the immediate vicinity of the generator.
- 5.4. Disconnect any electrical equipment which may already be connected to the generator.

5.5. STARTING THE ENGINE

- 5.5.1. Open the petrol tap, see fig.2.13 by turning it down.
- 5.5.2. Move the ON/OFF switch, see fig.1.10 to the ON position.
- 5.5.3. Move the choke lever, fig.2.11 to position IØI.
- 5.5.4. Start the engine with the recoil starter, see fig.2.12 by pulling the handle forcefully. If the engine does not start, pull the handle again.
- 5.5.5. Push the choke lever, see fig.2.11 back again after the engine has started.

- **WARNING!** When starting with the recoil starter, the motor may recoil suddenly as it starts up, resulting in hand injuries. Wear protective gloves when starting the equipment.

5.6. CONNECTING EQUIPMENT TO THE GENERATOR

- 5.6.1. Connect the equipment you want to use to the 230V sockets, see fig.1.3.

Important: These sockets may be loaded continuously (S1) with 2000W and temporarily (S2) for a maximum of 2 minutes with 2200W.

5.6.2. The generator is suitable for 230 V~ AC appliances.

5.6.3. **DO NOT** connect the generator to the domestic power network as this may result in damage to the generator itself or to other electrical appliances in your home.

Note: Some electrical appliances (power jigsaws, drills, etc.) may have a higher level of power consumption when used in difficult conditions.

5.7. SWITCHING OFF THE ENGINE

5.7.1. Before you switch off the generator, allow it to run briefly with no consumers so that it can "cool down".

5.7.2. Move the ON/OFF switch, see fig.1.10 to OFF position.

5.7.3. Close the petrol tap.

Important! The generator is fitted with an overload cut-out. This shuts down the sockets, see fig.1.3. You can restart the sockets by pressing the overload cut-out, see fig.1.5.

Important! If this happens, reduce the electric power you are taking from the generator or remove any defective connected appliances.

Important! Defective overload cut-outs must be replaced only by overload cut-outs of identical design and with the same performance data. If repairs are necessary, please contact your Sealey stockist.

6. MAINTENANCE

Note: Switch off the motor and pull the spark plug boot from the spark plug before doing any cleaning and maintenance work on the equipment. **Important:** Switch off the machine immediately and contact your Sealey stockist: In the event of unusual vibrations or noise or if the engine appears to be overloaded or misfires.

6.1. CLEANING

6.1.1. Keep all safety devices, air vents and the motor housing free of dirt and dust as far as possible.

6.1.2. Wipe the equipment with a clean cloth or blow it with compressed air at low pressure.

6.1.3. We recommend that you clean the device immediately each time you have finished using it. Clean the equipment regularly with a moist cloth and some soft soap. Do not use cleaning agents or solvents; these could attack the plastic parts of the equipment. Ensure that no water can seep into the device.

6.2. AIR FILTER see fig.5

6.2.1. Clean the air filter at regular intervals, and replace it if necessary.

6.2.2. Open both clips, see fig.4.A and remove the air filter cover, see fig.4.B.

6.2.3. Remove the filter elements, see fig.5.C. **DO NOT** use abrasive cleaning agents or petrol to clean the elements. Clean the elements by tapping them on a flat surface. In cases of stubborn dirt first clean with soapy water, then rinse with clear water and air dry.

6.2.4. Assemble in reverse order.

6.3. SPARK PLUG see fig.6.

6.3.1. Check the spark plug for dirt and grime after 20 hours of operation and if necessary clean with a copper wire brush. Thereafter service the spark plug after every 50 hours of operation.

6.3.2. Pull off the spark plug boot with a twist.

6.3.3. Remove the spark plug with the supplied spark plug wrench.

6.3.4. Assemble in reverse order

6.4. CHANGING THE OIL AND CHECKING THE OIL LEVEL (BEFORE USING THE MACHINE) see fig.3.

6.4.1. The motor oil is best changed when the motor is at working temperature.

6.4.2. Only use motor oil (15W40).

6.4.3. Place the generator on a slightly inclined surface so that the oil drain plug is at the lower end. Open the oil filler plug. Open the oil drain plug and let the hot engine oil drain out into a drip tray.

6.4.4. After the old oil has drained out, close the oil drain plug and place the generator on a level surface again.

6.4.5. Fill in engine oil up to the top mark on the oil dip stick (approx. 0.6L).

Important: DO NOT screw the dipstick in to check the oil level, simply insert it up to the thread.

6.4.6. Dispose of the waste oil properly.

6.5. AUTOMATIC OIL CUT-OUT LIGHT/SWITCH see fig.1.9 & 1.9A.

6.6. The automatic oil cut-out responds if there is too little oil in the engine. In this case it will not be possible to start the engine or it will cut out automatically after a short period of time. It cannot be started again until the engine oil has been topped up, see 6.4.



ENVIRONMENT PROTECTION

Recycle unwanted materials instead of disposing of them as waste. All tools, accessories and packaging should be sorted, taken to a recycling centre and disposed of in a manner which is compatible with the environment. When the product becomes completely unserviceable and requires disposal, drain any fluids (if applicable) into approved containers and dispose of the product and fluids according to local regulations.



WEEE REGULATIONS

Dispose of this product at the end of its working life in compliance with the EU Directive on Waste Electrical and Electronic Equipment (WEEE). When the product is no longer required, it must be disposed of in an environmentally protective way. Contact your local solid waste authority for recycling information.

Note: It is our policy to continually improve products and as such we reserve the right to alter data, specifications and component parts without prior notice. Please note that other versions of this product are available. If you require documentation for alternative versions, please email or call our technical team on technical@sealey.co.uk or 01284 757505.

Important: No Liability is accepted for incorrect use of this product.

Warranty: Guarantee is 12 months from purchase date, proof of which is required for any claim.

Sealey Group, Kempson Way, Suffolk Business Park, Bury St Edmunds, Suffolk. IP32 7AR



01284 703534



sales@sealey.co.uk



www.sealey.co.uk