



90L STAINLESS STEEL FUEL TANK DRAINER

MODEL NO: TP201

Thank you for purchasing a Sealey product. Manufactured to a high standard, this product will, if used according to these instructions, and properly maintained, give you years of trouble free performance.

IMPORTANT: PLEASE READ THESE INSTRUCTIONS CAREFULLY. NOTE THE SAFE OPERATIONAL REQUIREMENTS, WARNINGS & CAUTIONS. USE THE PRODUCT CORRECTLY AND WITH CARE FOR THE PURPOSE FOR WHICH IT IS INTENDED. FAILURE TO DO SO MAY CAUSE DAMAGE AND/OR PERSONAL INJURY AND WILL INVALIDATE THE WARRANTY. KEEP THESE INSTRUCTIONS SAFE FOR FUTURE USE.



Refer to
Instruction
Manual



Wear
Eye
Protection



Wear
Protective
Gloves



Explosion
Protection

1. SAFETY

Petrol is a highly flammable liquid and any spillage will evaporate to form a flammable, heavier than air vapour which is easily ignited. Common ignition sources include, but are not limited to, smoking and lit matches, welding and cutting equipment, heaters, all types of electrical equipment unless specifically designed as suitable for use in flammable atmosphere. Even low voltage inspection lamps, if damaged, can ignite petrol vapour

Please take time to read the following safety information before commencing work with the TP201.

- Use the drainer only for its intended purpose.
- ✓ Familiarise yourself with the applications, limitations, and potential hazards of this product.
- ✓ Use original Sealey spare parts only. Unauthorised parts may be dangerous and will invalidate the warranty.
- ✓ We recommend that the TP201 is used outdoors or in a well ventilated area, and well away from pits or other openings in the ground where vapour can collect.
- ✓ Disconnect the vehicle's battery before draining fuel.
- ✓ Keep a foam or dry powder fire extinguisher nearby.
- ✓ Ensure containers cannot easily be knocked over during filling.
- ✓ Ensure the drainer tank is large enough to hold the contents of the fuel tank being drained.
- ✓ Ensure space required for use and maintenance of the drainer is adequate, free from unrelated materials and has good lighting.
- ✓ Attach earth lead to the fuel container using the crocodile clip supplied.
- ✓ Always use the earth bonding straps by connecting one to the vehicle chassis, away from any potential fuel vapour, and the other to a suitable earthing point.
- ✓ Remove all combustible materials from the work area.
- ✓ Use only containers rated for the fuel being drained. Ensure that the container mouth is as narrow as possible while still allowing insertion of the drain hose.
- ✓ HSE guidance recommends use of metal containers with secure caps for holding drained fuel.
- ✓ Mark fuel containers with hazard labels to show their contents.
- ✓ Keep any fuel containers in a well ventilated, lockable store, preferably outside the working area.
- ✓ Soak up any spills immediately using absorbent granules or similar material.
- ✓ Keep children and unauthorised persons away from the working area, especially when the drainer is in operation.
- ✓ Maintain the drainer in top condition. Keep it clean for best and safest performance.
- ✓ Follow the same precautions when transferring fuel from the drainer back into the vehicle or into any other container.
- ✗ **DO NOT** use this drainer for anything other than its intended purpose. The TP201 is only to be used for pumping fuel from diesel or petrol vehicles.
- ✗ **DO NOT** work on a fuel tank or remove a sender unit before draining the fuel.
- ✗ **DO NOT** use an open flame or smoke anywhere near the drainer or around stored fuel.
- ✗ **DO NOT** drain fuel into open-topped containers such as buckets and watering cans.
- ✗ **DO NOT** drain fuel into dedicated workshop oil drain equipment.
- ✗ **DO NOT** drain fuel into plastic containers except for quantities less than 10 litres.
- ✗ **DO NOT** allow work which can produce a source of ignition, such as welding, electrical or other hot work, to be carried out while draining petrol.
- ✗ **DO NOT** drain fuel over, or close to, a pit or drain because of the risk of flammable vapour accumulation.
- ✗ **DO NOT** use any electrical equipment on or near the vehicle while fuel draining is in progress. This includes the use of inspection lights, cordless/mobile phones or pagers.
- ✗ **DO NOT** store drained or contaminated fuel in the workplace unless it is to be returned to the vehicle immediately.
- ✗ **DO NOT** add drained fuel to the waste oil tank.
- ✗ **DO NOT** wear clothing on which petrol has been spilt - stop work and change into uncontaminated clothing before continuing to work.
- ✗ **DO NOT** use the drainer if the pump is damaged in any way.
- ✗ **DO NOT** leave the unit running unattended.
- ✗ **DO NOT** use whilst under the influence of drugs, alcohol or other intoxicating medication, or if you are fatigued.
- ✗ **DO NOT** use the drainer for a job it was not designed to do.
- ✗ **DO NOT** tamper with the safety valve fitted to the tank.

Users/Businesses should perform their own hazard risk assessment based on their specific environment and following the guidelines laid out above.

2. INTRODUCTION

Stainless steel fuel drainer with venturi type suction. 90L Capacity tank suitable for petrol or diesel. Supplied with suction tubes and adaptors for breaking into vehicle fuel system. CE Certified (ATEX 2014/34/EU).

3. SPECIFICATION

Model No: TP201
 Tank Capacity: 90L
 Recommended Air Pressure: 70-100psi
 Air Consumption: 12cfm
 Adaptors: A (6.5,8.5,10.5), B (M10,M12,M14)

4. OPERATION

The TP201 is only to be used for pumping fuel from either a diesel or petrol vehicle. Any other use can be dangerous and will invalidate the warranty. The unit should be reserved for only one type of fuel. Do not mix different fuels in the unit unless the unit is being used to drain a tank where fuels have been inadvertently mixed, in which case the unit should be reserved exclusively for this purpose. Bring the unit near the vehicle when ready to begin transferring fuel. Draining can be carried out in different ways depending on the vehicle's configuration. Before beginning the draining process, ensure you have read and understood the safety warnings and guidelines listed in Section 1 of these instructions.

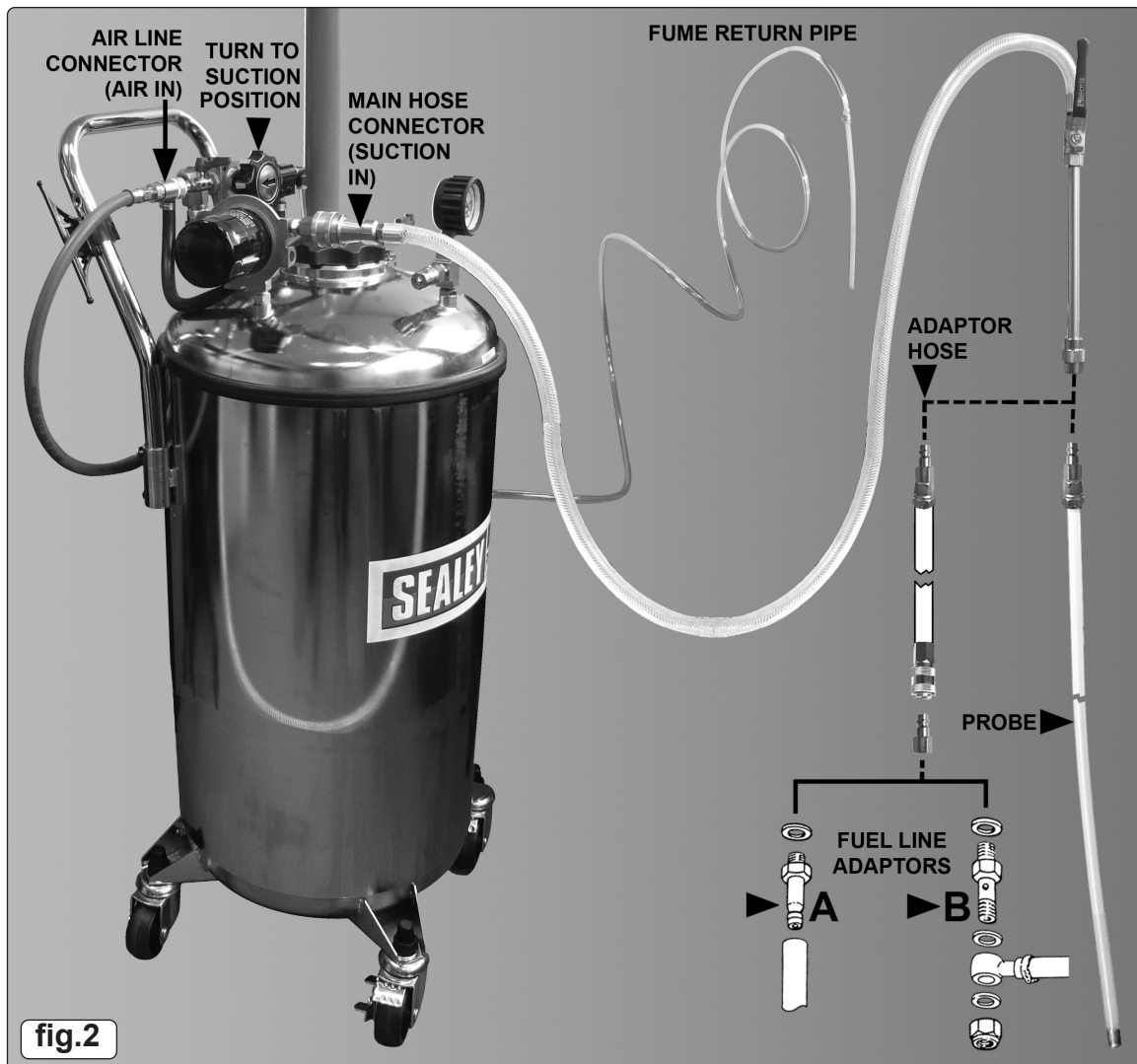
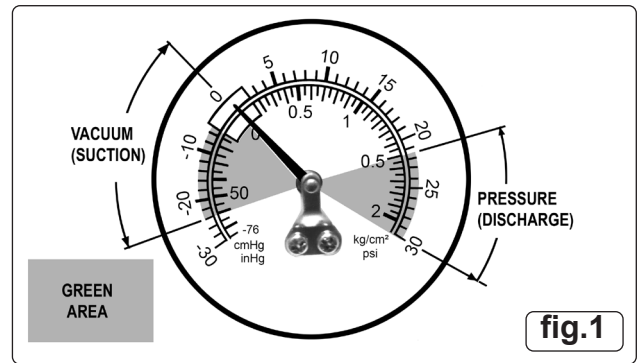

- 4.1. Assemble Handle. Remove the screws from the tubular handle supports and insert the ends of the handle into the two short lengths of tube. See fig.2. Align the threaded holes in the handle with the two holes in each support tube and secure each side with the two screws previously removed.
- 4.2. **Earth Bonding Straps.** Attach one clamp on each earth bonding strap to a suitable point on the unit ensuring that it has metal to metal contact and is secure. Attach the clamp from one strap to the vehicle's chassis, away from any potential fuel vapour, and the clamp from the other strap to a suitable earthing point. When the bonding straps are not being used wrap the wires around the black cable ties attached to the handle.
 - ❑ **WARNING:** The operator must not leave the unit unattended during draining and should observe the fuel level in the sight tube on the side of the TP201 tank and shut the unit down when it is full.
 - ▲ **IMPORTANT:** These instructions are provided as a guide only. Always refer to the vehicle manufacturers' instructions or a proprietary manual to establish the correct procedure and data.
- 4.3. **Carburettor engine vehicles.** Fuel can be transferred from carburettor engine vehicles through the carburettor's fuel inlet pipe.
 - 4.3.1. If this is necessary, use one of the six adaptors supplied. See type 'A' above and fig.4A. Choose the correct diameter adaptor for

the fuel line in question.

- 4.3.2. Screw the adaptor and washer into the quick coupling adapter (fig.2) and then connect that into the end of the adaptor hose.
- 4.3.3. Plug the male fitting on the other end of the adaptor hose into the quick connector on the end of the main hose. See above.

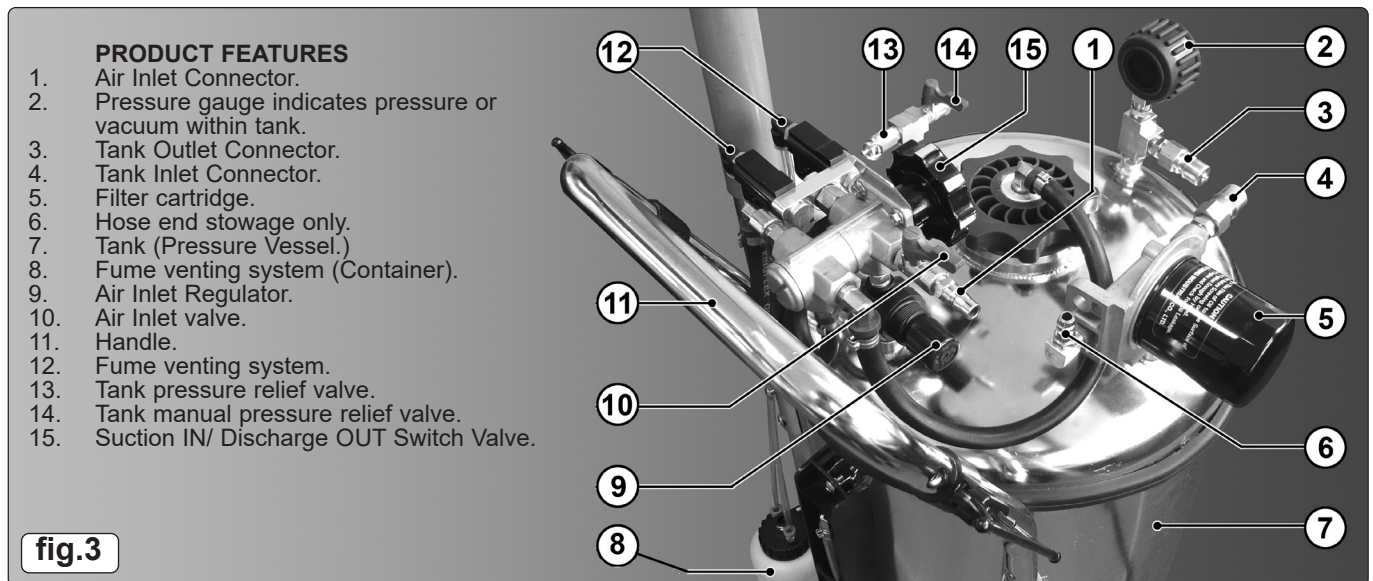

- 4.3.4. Plug the female fitting on the other end of the main hose into the quick connector mounted on the filter bracket. See above and fig.3-4.
- 4.3.5. Disconnect the carburettor's fuel inlet pipe and push it onto the fuel line adaptor.
- 4.4. **Fuel-injected vehicles.** Fuel can be transferred from fuel-injected vehicles through the injector's fuel inlet pipe.
 - 4.4.1. Use connector type 'B' (see fig.2). Choose the required diameter. See fig.4B.
 - 4.4.2. Screw the adaptor and washer into the quick coupling adapter (fig.2) and then into the adaptor hose.
 - 4.4.3. Plug the male fitting on the other end of the adaptor hose into the quick connector main hose. See fig.2
 - 4.4.4. Plug the male fitting on the other end of the main hose into the quick connector mounted on the filter bracket. See fig.2 and fig.3-4.
 - 4.4.5. Disconnect the vehicle's fuel inlet pipe coming from the tank and slide the 'banjo' fitting onto the adaptor.
 - 4.4.6. Use the two gaskets from the ring removed from the car to obtain a good seal.
- 4.5. **Transferring fuel directly from the tank.**
 - 4.5.1. Connect one of the 5 probes to the metal extension tube as shown in fig.2.
 - 4.5.2. If the vehicle is fitted with an anti-theft device at the fuel tank inlet access to the tank may be gained from the boot through a porthole, closed by a guard or a safety device. Remove the guard, and the relevant cap and insert the probe into the hole. This will allow quicker transfer of fuel than the previous two methods.
 - 4.5.3. In older vehicles, the probe can be inserted directly into the fuel tank through the fuel tank inlet.
 - 4.5.4. Insert the fume return pipe into the same opening as the collection probe. See fig.2.
- 4.6. **Connect the workshop air supply.** Recommended hook-up procedure is shown in fig.5 below.
 - 4.6.1. Ensure the air inlet tap (fig.3-10) is OFF before connecting to the air supply.
 - 4.6.2. You will require an air pressure of 72 -100psi, and an air flow of 12cfm.
 - ☐ **WARNING!** Ensure the air supply is clean and does not exceed 100 psi while operating the drainer. Too high an air pressure and unclean air will shorten the product life due to excessive wear, and may be dangerous causing damage and/or personal injury.
 - 4.6.3. Drain the air tank daily. Water in the air line will damage the air motor.
 - 4.6.4. Clean air inlet filter weekly.
 - 4.6.5. Line pressure should be increased to compensate for unusually long air hoses (over 8 metres). The minimum hose diameter should be 1/4" I.D. and fittings must have the same inside dimensions.

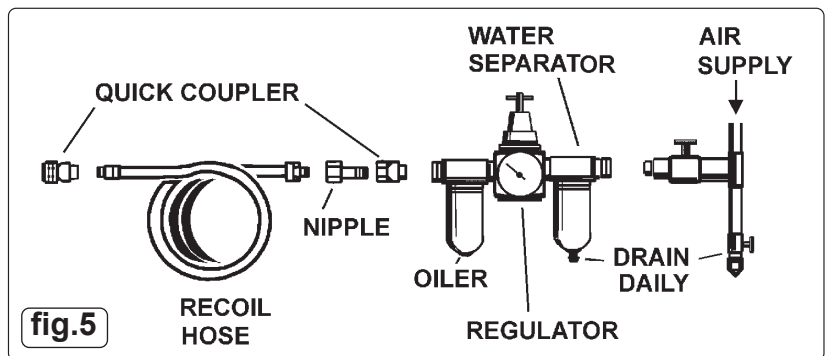
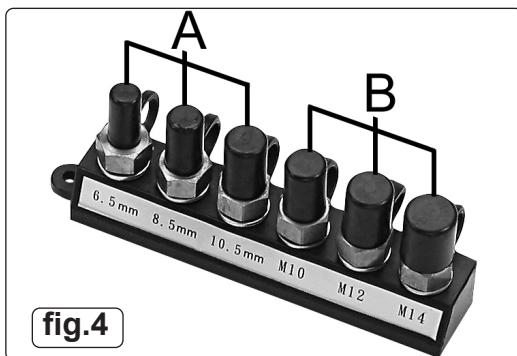

- 4.6.6. Keep hose away from heat, oil and sharp edges. Check hoses for wear, and make certain that all connections are secure.
- 4.7. **Set the controls for suction.**
 - 4.7.1. Turn the Suction/Discharge valve selector (fig.3-15) to the SUCTION position.
 - 4.7.2. Set the air pressure on the incoming supply to between 72 and 100psi.
- 4.8. Open the air inlet valve on the unit. (fig.3-10) Using the regulator on the unit (fig.3-9) increase the vacuum gradually down to -60cmHg until suction starts. Monitor the vacuum in the tank using the pressure gauge (fig.3-2). The needle should remain in the green area on the left hand side of the gauge (see fig.1).
- 4.9. **Turn the unit off.** When draining of the vehicle tank is finished turn the unit off by closing the air inlet valve (see fig.3-10).

- 4.9.1. Unless the fuel is to be returned to the vehicle immediately, it should be transferred to an approved container and stored in a designated lockable, well-ventilated area, preferably outside the workshop.
- 4.10.2. Any contaminated fuel or petrol/diesel mixtures should be consigned to waste, giving a clear description of the nature of the material

4.10. Draining the tank on the TP201.

IMPORTANT. Before starting the draining process turn the selector valve (fig.3-15) to the discharge position to allow the drainer tank to become pressurised.

- 4.10.1. The contents of the TP201 tank are drained off using the air pressure supplied by the local incoming air supply. The pressure of the incoming air supply can remain at the 72 to 100psi previously set for the suction process.
- 4.10.2. Ensure that you have a container ready that has a capacity equal to the amount of fuel to be discharged and is approved for the storage of petrol or diesel fuel. Remember that the TP201 can hold up to 90litrs.

- 4.11.** Connect the earth bonding straps. Ensure that a clamp on one end of each strap is securely attached to a metal part on the unit. Attach the other clip from one strap to a known earthing point, away from any potential fuel vapour, and the clip from the second

strap to the container. If necessary scrape away a small amount of paint from the container to improve the earth connection.

- 4.12. Insert tube into container.** Place the metal extension tube on the end of the main hose into the chosen container and open the valve (lever in line with metal tube). If necessary a probe can be connected to the end of the metal tube.

- 4.12.1. Ensure that the female connector on the other end of the main hose is connected to the male inlet connector attached to the pressure gauge. See fig.6 and fig.3-3.

Open the air inlet valve on the unit to start the draining process. (fig.3-10) Using the regulator on the unit (fig.3-9) increase the pressure gradually to between 23 and 30psi until draining starts. Monitor the pressure in the tank using the pressure gauge (fig.3-2). The needle should remain in the green area on the right hand side of the gauge (see fig.1).

❑ **Do not set the pressure too high as this could result in the tank pressure relief valve operating and the possible venting of fuel.**

- 4.13. Turn the unit off.** When the transfer of fuel to the container is finished turn the unit off by closing the air inlet valve (see fig.3-10).

The fuel container should be stored in a designated lockable, well-ventilated area, preferably outside the workshop.

Any contaminated fuel or petrol/diesel mixtures should be consigned to waste, giving a clear description of the nature of the material.

- 4.14. Fume venting system.** The fume venting system is designed to protect the operator from fumes during operation of the unit. The fumes are collected at the top of the unit (see fig.3-12) and are fed through two plastic pipes to a small container mounted at the bottom of the unit (see fig.3-8 and fig.7). Small amounts of fuel will condense in this container before the fumes are fed through the fume return pipe back to the source tank/vehicle. Periodically check the fume container for accumulated fuel and empty it if the container is more than 1/3 full.

Dispose of any fuel according to local authority regulations.

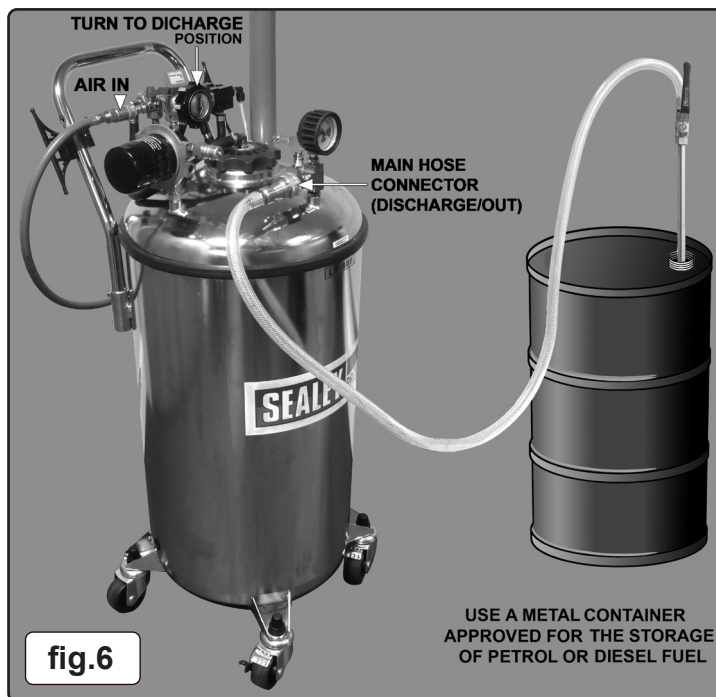

fig.6

USE A METAL CONTAINER APPROVED FOR THE STORAGE OF PETROL OR DIESEL FUEL

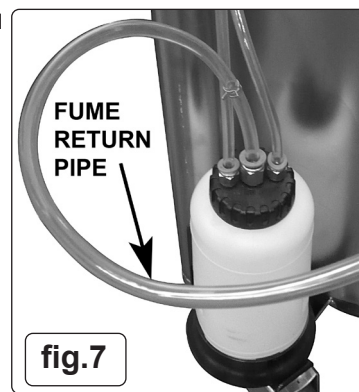

fig.7

5. MAINTENANCE

- 5.1.** Maintenance, service and repair should only be carried out by qualified persons.
- 5.2.** Check the condition of the transfer hoses. Make sure that they are intact and undamaged, without cracks, holes or leaks. If they are damaged or they leak, replace them.
- 5.3.** Check the condition of the adaptors and associated washers. Be sure that they are undamaged and can maintain a perfect seal. Replace them with original spare parts if they are defective. Periodically check the earth strap terminals for tightness and that the wire and clamps are in good order.
- 5.4.** Replace the fuel filter on a regular basis. Care should be taken when unscrewing the filter to capture any spilt fuel using rags or absorbent paper towel. Dispose of any fuel soaked material according to local authority regulations.

ENVIRONMENT PROTECTION



Recycle unwanted materials instead of disposing of them as waste. All tools, accessories and packaging should be sorted, taken to a recycling centre and disposed of in a manner which is compatible with the environment. When the product becomes completely unserviceable and requires disposal, drain any fluids (if applicable) into approved containers and dispose of the product and fluids according to local regulations.



Note: It is our policy to continually improve products and as such we reserve the right to alter data, specifications and component parts without prior notice.

Important: No Liability is accepted for incorrect use of this product.

Warranty: Guarantee is 12 months from purchase date, proof of which is required for any claim.

Sealey Group, Kempson Way, Suffolk Business Park, Bury St Edmunds, Suffolk. IP32 7AR



01284 757500



sales@sealey.co.uk



www.sealey.co.uk